

Project Name:	
Type:	

QM50 Series

50 Watts Max, 110-277VAC
High Power Constant Current LED Driver

PRODUCT FEATURE

- Compact size maximizes design flexibility.
- Low flickering – Less than 10% up to 120Hz
- No-load power consumption less than 0.5W
- Turn on time – Less than 500mS
- Meeting CEC Title 24, JA-8.3.3 requirements
- 4 in 1 dimming – TRIAC/ELV/0-10V/PWM (see models)
- Available with dim-to-warm (see models)
- Dimming percentage to 1-2% - All dimming methods
- Optional dimming curve – linear or progression
- CC or CV output 4 in 1 dimming
- Easy quick “dip switch” output programming
- Wireless communication protocol using ZigBee or Casambi - Optional
- Transient Protection
- UL8750 supplement SF, Class 2; Class P and CE compliant

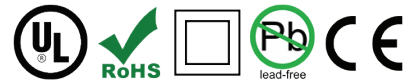

WARRANTY

- See [Limited Warranty Policy](#) for more additional information

SPECIFICATIONS

Input Range	:	110 - 277VAC / 0.30 - 0.15A / 47 - 63Hz
DC output Range	:	Refer to model selection table
Efficiency	:	87% Typical
Power Factor	:	> 0.98 at full load, 115VAC or 230VAC
Output Current Regulation	:	±5%
Protection	:	OCP, SCP, OVP - Auto recovery
Surge Rating	:	2.5 KVA
Dimming	:	Compatible with TRIAC / ELV / 0-10V / PWM
PWM dimming Signal	:	500Hz - 10Khz; Min. 10V amplitude
Operation Temp.	:	-30°C - +50°C, Tc : 90°C
Storage Temp.	:	-40°C - +85°C
Humidity (Non-Condensing)	:	5% to 95%
Vibration Frequency	:	5 to 50Hz
MTBF	:	>100,000 Hours, FULL load, 25°C Amb., MIL-217F
Regulation Compliance	:	UL8750 Supplement SF, Class P EN61347, EN55015, EN61547
Cooling	:	Convection
Dimension	:	4.23" x 1.71" x 1.26" (L x W x H)

RELATED PRODUCTS

- ↪ [QM32 Series](#)
- ↪ [QM40 Series](#)
- ↪ [QM70 Series](#)
- ↪ [QM100 Series](#)

MODEL SELECTION

MODEL NUMBER	LED ch#	DC OUTPUT RANGE (Vf)	MAX OUTPUT CURRENT (mA)	Max output power (W)	TOTAL POWER (1+2)
QM50-U48Z-yyyy-XP	1	10 – 48 VDC ^{Note 5}	1250	50	50
	2	10 – 48 VDC ^{Note 5}	1250	50	
QM50-U48Z-yyyy-XP (1)	1	10 – 48 VDC ^{Note 5}	1250	50	50
	2	10 – 48 VDC ^{Note 5}	1250	50	
QM50-U24Z-yyyy-XP	1	24 VDC	1900	46	50
	2	24 VDC	1900	46	

NOTE 1: “yyyy” = Standard output current is (1250 or 0850) Please refer to output current chart;
XP = 94V-0 plastic case

NOTE 2: Custom output current configuration available.

NOTE 3: “z” = “S” single output; “D” dual outputs

NOTE 4: “UM50-U48z-yyyy-XP (1)” is non-AC Dim option

NOTE 5: Please refer to performance chart for more details.

POWER FACTOR VS LOAD

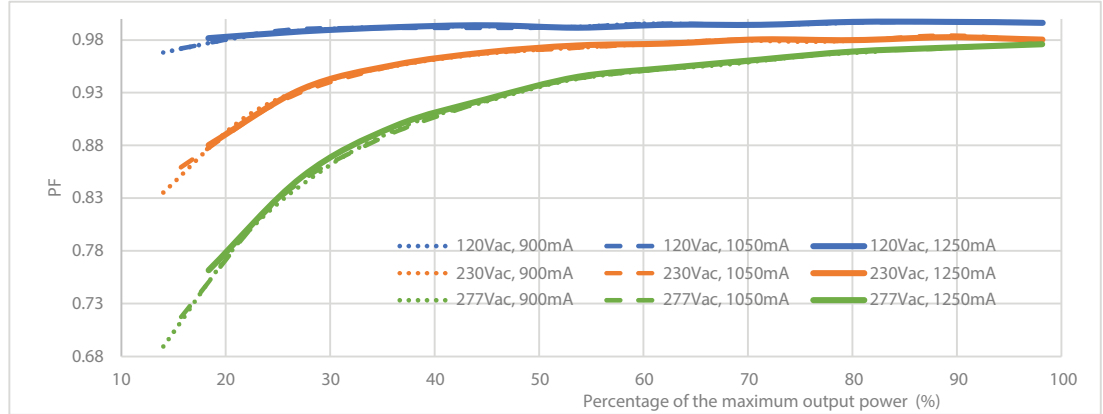

THD VS LOAD

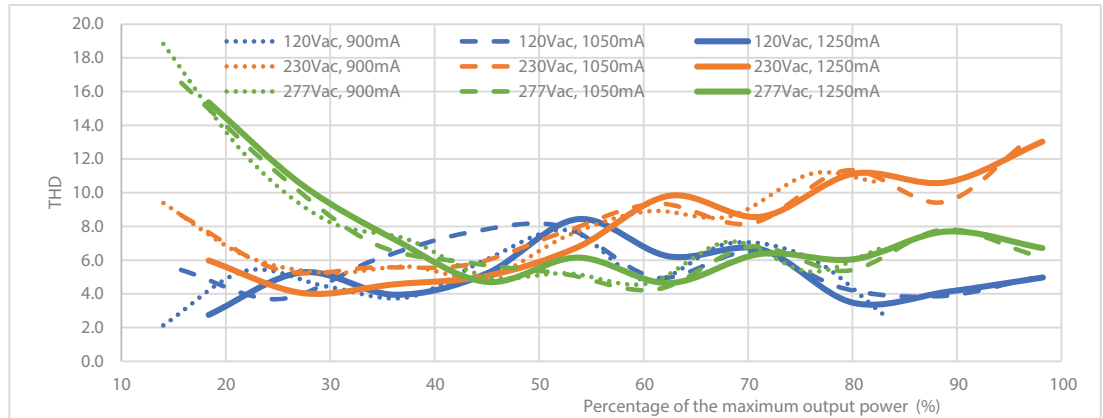

EFFICIENCY VS LOAD

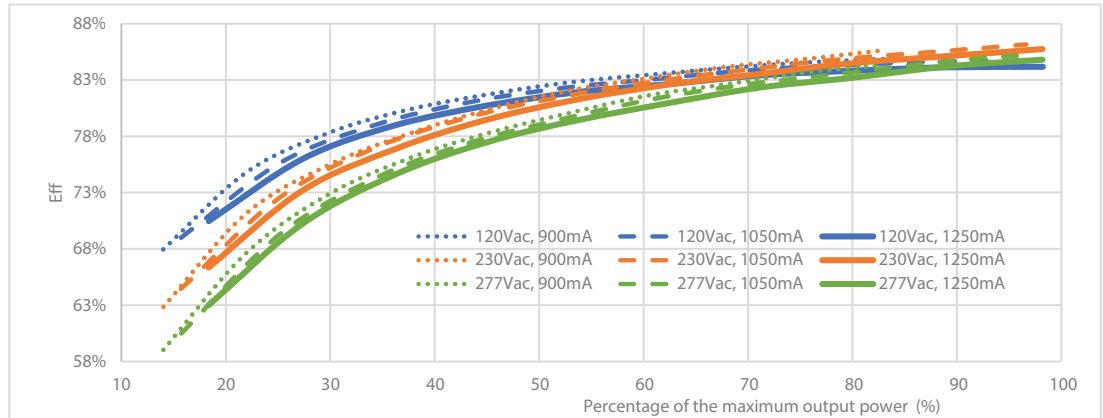

Note: The above reports are generated using QM50-U48D-1250-XP with forward voltage range from 7VDC to 48V.

DE-RATING TEMP VS LOAD

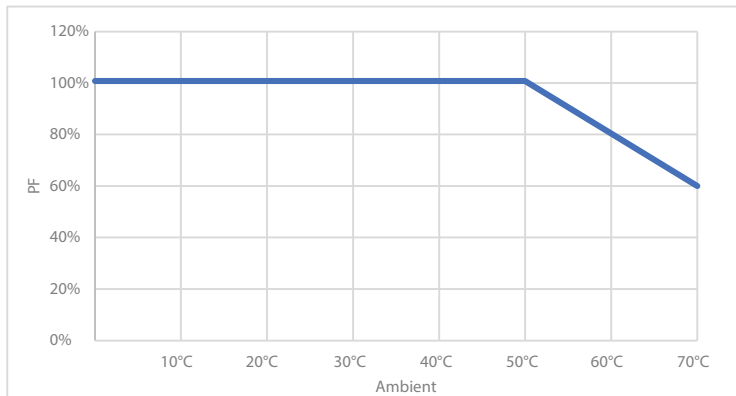

Project Name:	
Type:	

QM50 Series

50 Watts Max, 110-277VAC
High Power Constant Current LED Driver

QM50-U48D-1250 0-10V DIMMING GRAPH AT 120VAC

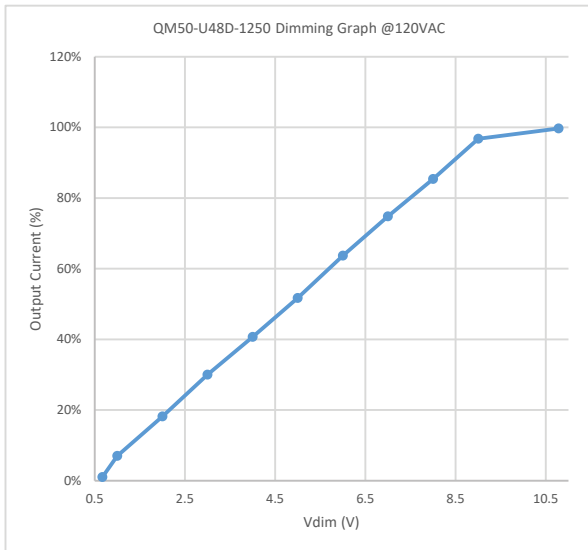

QM50-U48D-1250 0-10V DIMMING GRAPH AT 277VAC

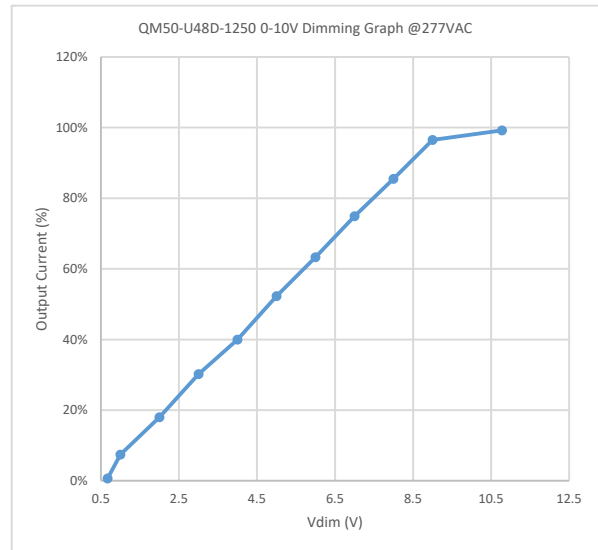

QM50-U48D-1250 ELV DIMMING GRAPH-ERCO

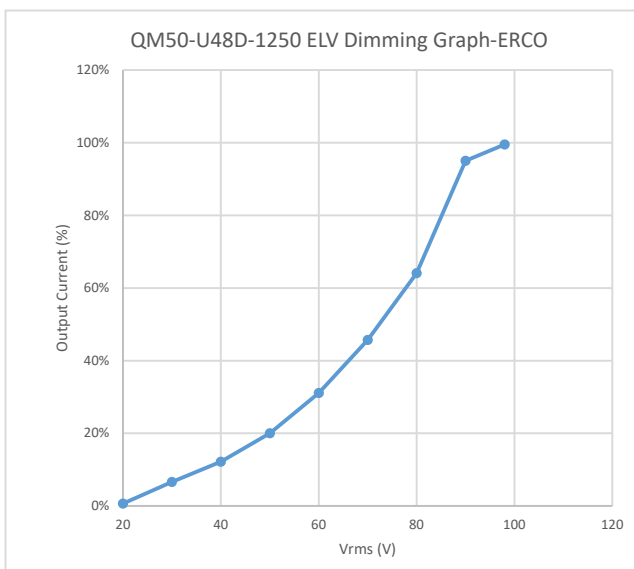

QM50-U48D-1250 TRIAC DIMMING GRAPH-ERCO

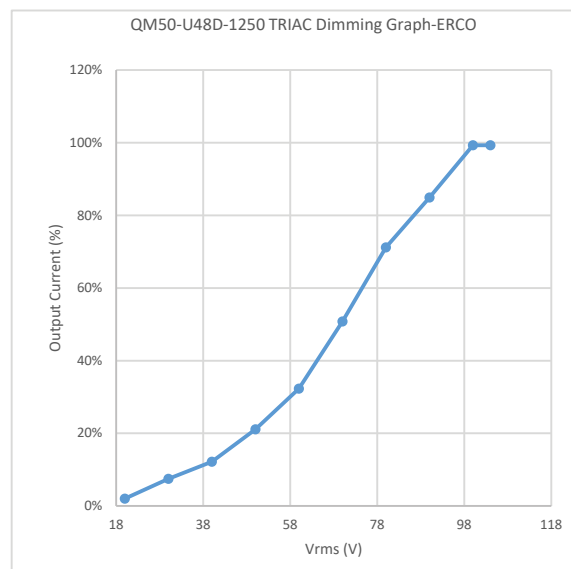

Project Name:	
Type:	

QM50 Series

50 Watts Max, 110-277VAC
High Power Constant Current LED Driver

LIFE TIME VS AMBIENT TEMPERATURE

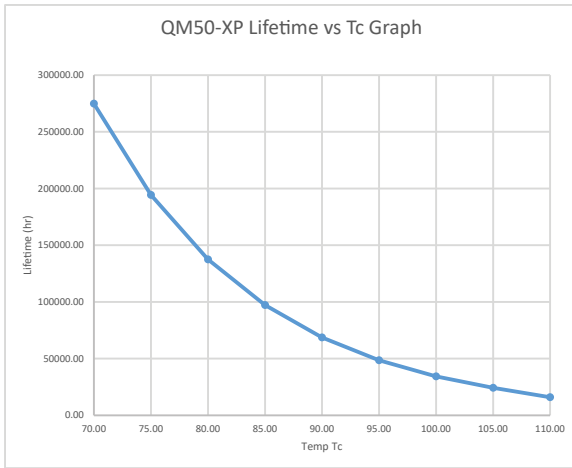

WIRING DIAGRAM

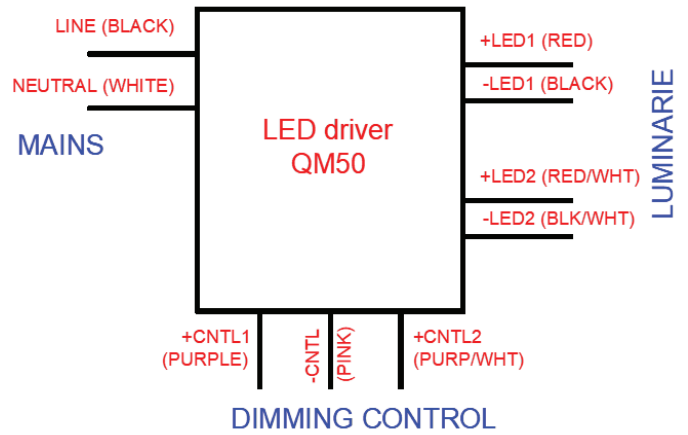

SWITCHES SETTING CHART

SW1	SW2	SW3	SW4	SW5	SW6	SW7
-----	-----	-----	-----	-----	-----	-----

SW1, SW2, SW3 are for output current settings (output setting accuracy: ±2.5%)

OUTPUT (mA)	-0850			SW4
	SW1	SW2	SW3	
500	Off	Off	Off	Dim to off = Off Dim to on = On
550	On	Off	Off	
600	Off	On	Off	
650	On	On	Off	
700	Off	Off	On	
750	On	Off	On	
800	Off	On	On	
850	On	On	On	

OUTPUT (mA)	-1250			SW4
	SW1	SW2	SW3	
900	Off	Off	Off	Dim to off = Off Dim to on = On
950	On	Off	Off	
1000	Off	On	Off	
1050	On	On	Off	
1100	Off	Off	On	
1150	On	Off	On	
1200	Off	On	On	
1250	On	On	On	

SW4 is for DIN to on or DIM to off

DIMMING STATUS	DIMMING STATUS
	SW4
Dim to Off	Off
Dim to On	On

SW5, SW6 is to setup 0-10v dimming functions

MODE	0-10V DIMMING MODE	
	SW5	SW6
1	Off	On
2	On	On
3	Off	Off
4	On	Off

Project Name:	
Type:	

QM50 Series

50 Watts Max, 110-277VAC
High Power Constant Current LED Driver

QM50 - DUAL OUTPUT LED DRIVER MODES OF OPERATION

MODE 1

CONTROL BOTH OUTPUTS WITH ONE DIMMER

0~10V dimmer connected on DIM CNTL 1 can control the brightness on both output channels simultaneously.

SW5	SW6	OUTPUT 1 (RED-BLACK)	OUTPUT 2 (RED/WHT-BLK/WHT)	DIM CNTL 1 (PURPLE-PINK)	DIM CNTL 2 (PURPLE/WHT-PINK)
OFF	ON	1ST LED	2ND LED	For the brightness of LEDs on OUTPUT 1 and OUPUT 2	NA

MODE 2

CONTROL EACH OUTPUT WITH THE ASSIGNED DIMMER

0~10V DIMMER on the CNTL 1 only adjusts the brightness of LED on OUTPUT 1; 0~10V DIMMER on the CNTL 2 only adjusts the brightness of LED on OUTPUT 2;

SW5	SW6	OUTPUT 1 (RED-BLACK)	OUTPUT 2 (RED/WHT-BLK/WHT)	DIM CNTL 1 (PURPLE-PINK)	DIM CNTL 2 (PURPLE/WHT-PINK)
ON	ON	1ST LED	2ND LED	For the brightness of LED on OUTPUT 1	For the brightness of LED on OUTPUT 2

MODE 3

DIM TO WARM

Only connect one 0~10V on CNTL 1. The dimmer adjusts the brightness and color mixing between the LEDS on both outputs, the lower the brightness the warmer the color temperature.

SW5	SW6	OUTPUT 1 (RED-BLACK)	OUTPUT 2 (RED/WHT-BLK/WHT)	DIM CNTL 1 (PURPLE-PINK)	DIM CNTL 2 (PURPLE/WHT-PINK)
OFF	OFF	WHITE LED	WARM LED	For brightness and color temperature	NA

MODE 4

COLOR TUNNING

One 0~10V dimmer on CNTL1 and one 0~10V dimmer on CNTL2; CNTL 1 for brightness, CNTL 2 for color tuning.

SW5	SW6	OUTPUT 1 (RED-BLACK)	OUTPUT 2 (RED/WHT-BLK/WHT)	DIM CNTL 1 (PURPLE-PINK)	DIM CNTL 2 (PURPLE/WHT-PINK)
ON	OFF	WHITE LED	WARM LED	For brightness	For color temperature

MECHANICAL SPECIFICATION

CON	PIN	COLOR	OUTPUT
AC IN	-	BLACK	LINE
	-	WHITE	NEUTRA
OUT	LED1	RED	+
		BLACK	-
	LED2	RED/WHITE	+
		BLACK/WHITE	-
DIM	CNTL1+	PURPLE	+
	DIM	PINK	-
	CNTL2+	PURPLE/WHITE	+

