

Project Name:	
Type:	

M28-U Series

30 Watts max | 110 - 277VAC

PRODUCT FEATURE

- Compact size maximizes design flexibility.
- Available in plastic and stud-mount metal enclosures
- Fully potted, suitable for dry and damp location applications
- Compatible with Standard Electronics Low Voltage Dimmers
- UL8750 Class 2 and CE compliant
- Full range AC input from 115 ~ 277V

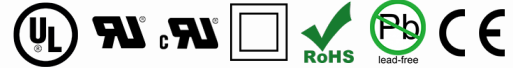

ELECTRICAL SPECIFICATIONS

INPUT RANGE	:	100 - 277VAC / 0.30 - 0.15A/ 47 - 63Hz
DC OUTPUT RANGE	:	Refer to Model selection table
EFFICIENCY	:	87% Typical
OUTPUT CURRENT REGULATION	:	±5%
PROTECTION	:	OCP, SCP, OVP - Auto Recovery
DIMMING	:	Compatible with ELV dimmers
POWER FACTOR	:	> 0.98 at full load, 115VAC or 230VAC
OPERATION TEMP.	:	-30°C - + 50°C, Tc: 80°C
STORAGE TEMP.	:	-40°C - + 85°C
MTBF(@25°C)	:	>100,000 hours, MIL-217F
REGULATION COMPLIANCE	:	UL8750 or EN61347, EN55015, EN61547
DIMENSION	:	3.49" x 1.64" x 1.20" (L x W x H)

ENVIRONMENTAL

OPERATING TEMPERATURE	:	-40 to 50°C
STORAGE TEMPERATURE	:	-40 to + 85°C
HUMIDITY (NON-CONDENSING)	:	5% to 95%
COOLING	:	Convection
VIBRATION FREQUENCY	:	5 to 50Hz
MTBF	:	>100,00 Hours at full load and 25°C ambient conditions (MIL-217F)

WARRANTY

- See [Limited Warranty Policy](#) for more additional information.

MODEL SELECTION

Model Number	DC Output Range (Vf)	Max. Output Current (mA)	Max. Output Power (W)
M28-U24-yyyy-Xz	15 ~ 24 VDC	1250	30
M28-U30-yyyy-Xz	16 ~ 30 VDC	1000	30
M28-U36-yyyy-Xz	20 ~ 36 VDC	830	30
M28-U42-yyyy-Xz	28 ~ 42 VDC	720	30
M28-U54-yyyy-Xz	40 ~ 54 VDC	625	30

"xx" = Output Voltage ; "yyyy" = Output current ; "z" = Case style and material, Xp = 94V-0 plastic ; Xm = stud-mount metal

M28-U Series

30 Watts max | 110 - 277VAC

Project Name:	
Type:	

DE-RATING TEMP. VS. LOAD

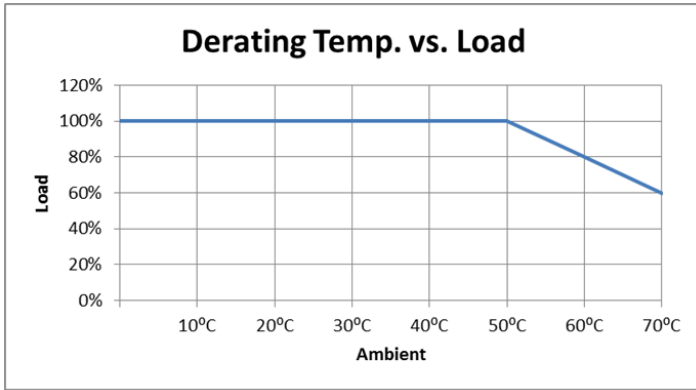

EFFICIENCY VS LOAD

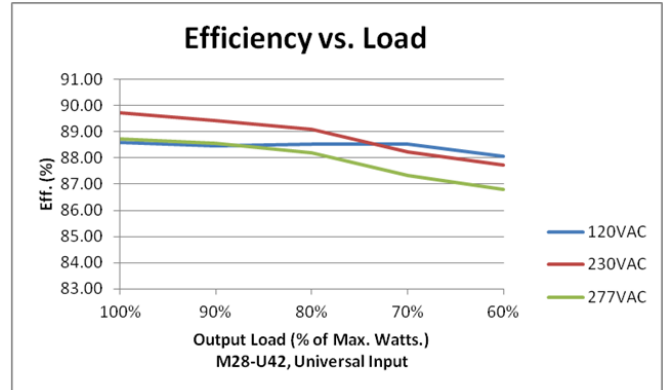

POWER FACTOR VS LOAD

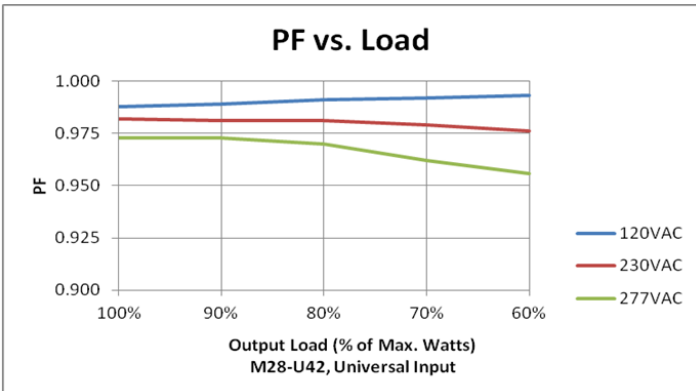

THD VS. LOAD

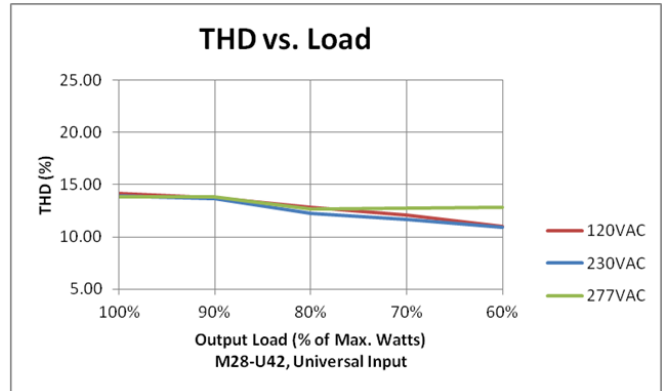

LIFE TIME VS. AMBIENT TEMP.

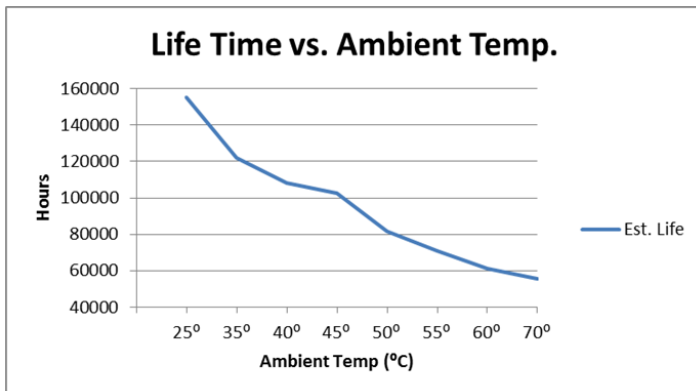

Project Name:	
Type:	

M28-U Series

30 Watts max | 110 - 277VAC

MECHANICAL DRAWING M28-Uxx-yyyy-Xz

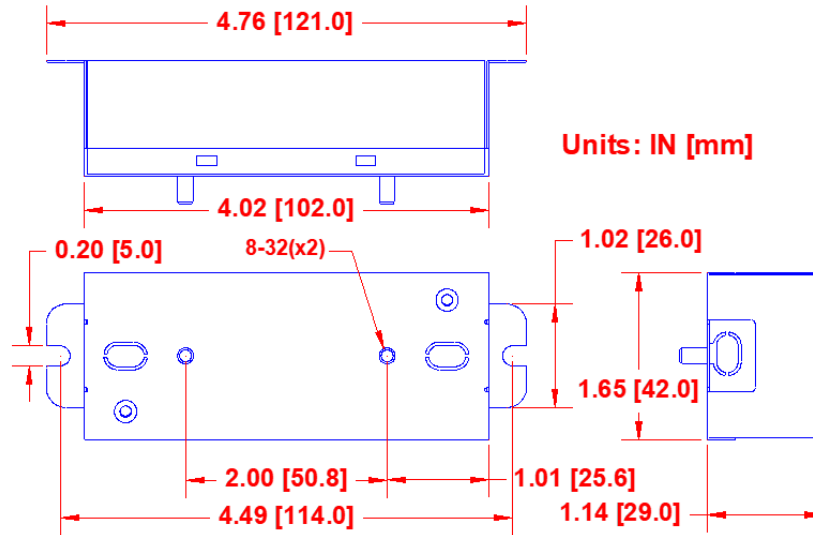

“Xm” – Stud-mountable Metal Case

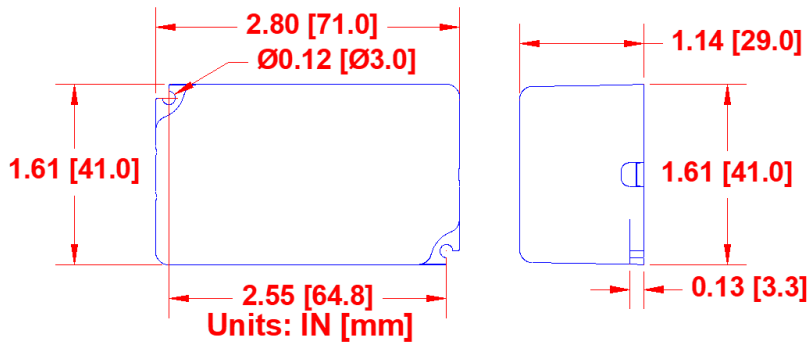

“M27-Xp” – Plastic

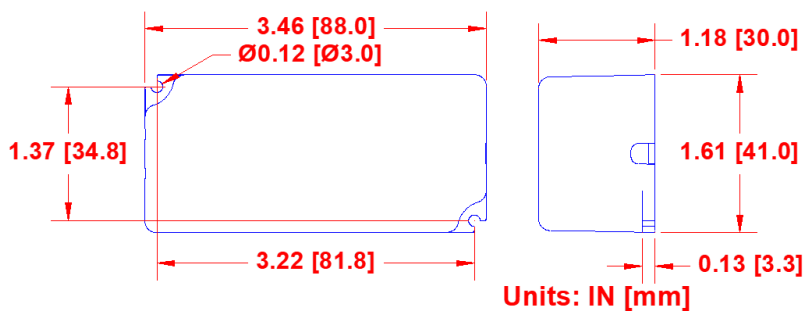

“M28-Xp” – Plastic