

REVISIONS		
REV	DESCRIPTION	DATE
A02	CHANGE FORMAT SIZE	11/19/2020
A01	LD1026 REMOVED	04/06/2017

B12R58

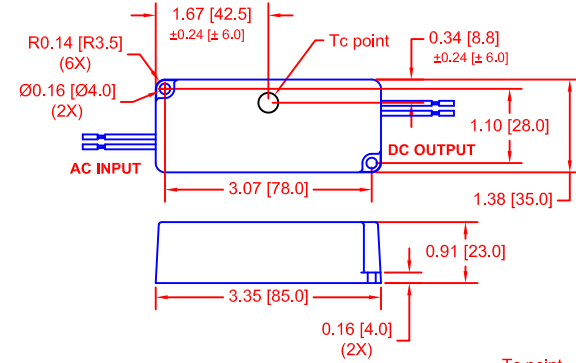

LA1012

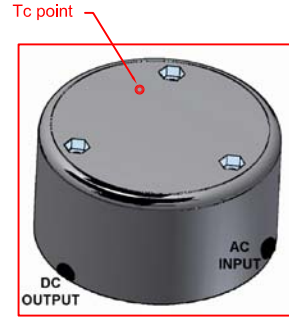
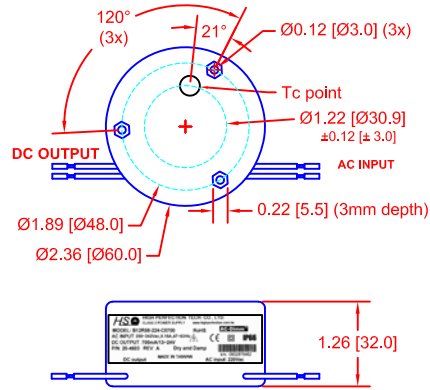
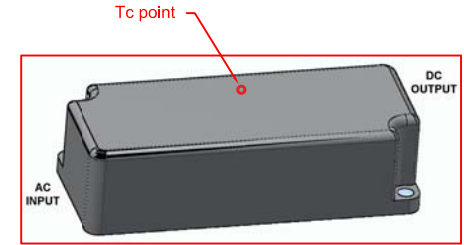

Tc=85°C

CC2512

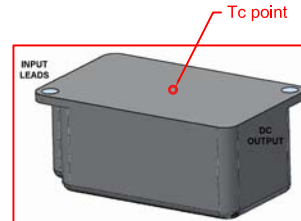
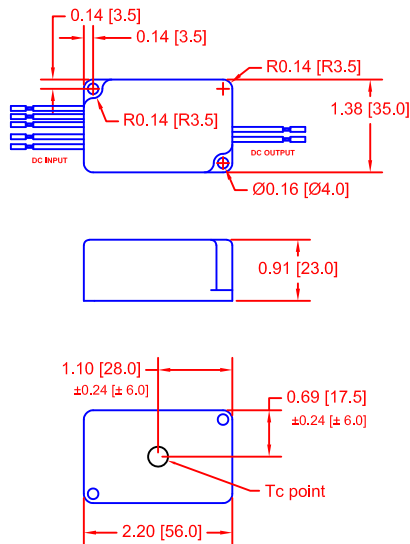

CC3512

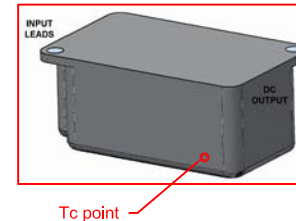
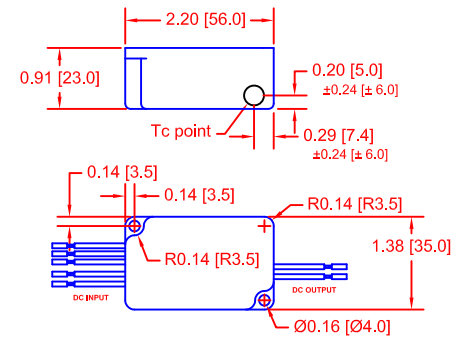

MANUFACTURED BY: HIGH PERFORMANCE TECHNOLOGY CO., LTD.

THIS ITEM IS THE PROPERTY OF MAGTECH INDUSTRIES AND CONTAINS PROPRIETARY CONFIDENTIAL AND TRADE SECRET INFORMATION. THE INFORMATION CONTAINED HEREIN MUST NOT BE USED, DISCLOSED OR REPRODUCED IN WHOLE OR IN PART WITHOUT PRIOR WRITTEN CONSENT FROM MAGTECH IND.

UNLESS OTHERWISE SPECIFIED	QC:			
DIMENSIONS IN INCHES (MM)				
TOLERANCES:		T I T L E : DRAWING, Tc POINT B12R58, CC2512, CC3512, LA1012, LD1026		
XX DECIMALS ± .05 (1.3)		DO NOT SCALE THIS DRAWING	APPROVAL DATE: ????	MODEL NO.
XX DECIMALS ± .02 (0.5)		INTERPRET DRAWING PER ANSI Y14.2M	EFFECTIVE DATE: ????	DWG NO. P07-0190
.XXX DECIMALS ± .005 (0.13)				REV. 02
ANGLES ± 1°				SH OF 1 1
FRACTIONS ± 1/16				